

For Exquisite Rooms and Furniture



Silent Aluflex 80 Sliding Door System
2009

Silent Aluflex 80 sliding door system: A wealth of options for people who want the best

Escape the mundane and discover something special: Unusual inspirations and surprising solutions for your space requirements. Let us tempt you with the ideas on the following pages. Let yourself be swept away by the creative applications for kitchens, dining rooms, bathrooms, offices and hallways. Make more of your rooms and your furniture - with Silent Aluflex 80

Individual style

Be it a living room in an old high-ceilinged city building, a cosy country home full of nooks and crannies, or a modern building, made to measure individual sliding doors can be installed up to a height of 2.5 metres and as wide as you like. The best shape, design and materials for your situation can be decided by your own personal lifestyle.

The convenience that you deserve

Silent Aluflex 80 offers unique living and operating convenience using well-engineered hardware; Large sliding doors are particularly impressive because of their maximum running safety and gentle, reliable closing - over the course of many years.

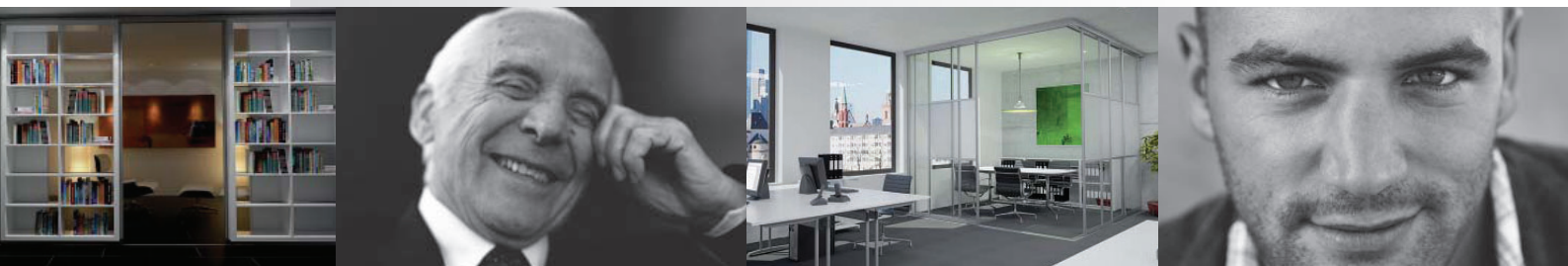

Contents

Kitchen and Dining	Pages 2 - 3
Bathroom	Pages 4 - 5
Wardrobe	Pages 6 - 7
Living Rooms	Pages 8 - 9
Offices	Pages 10 - 11
Insert Materials	Pages 12 - 13
Door Configuration and Combinations	Page 14
Sliding Door Frame and Track Specification	Page 15
Features and Benefits	Page 16

Silent Aluflex 80 Door Configuration Examples

Kitchen and Dining room divider

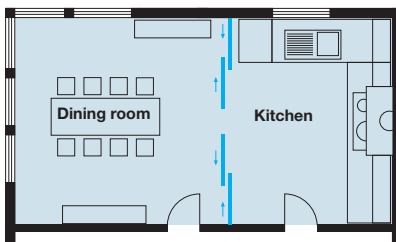

Bathroom door

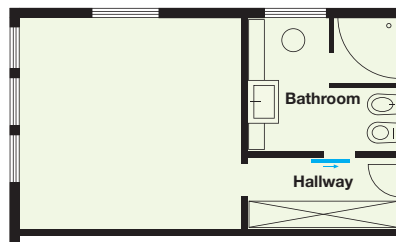

Walk-in-wardrobe

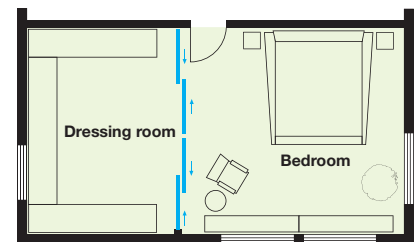

Wardrobe door

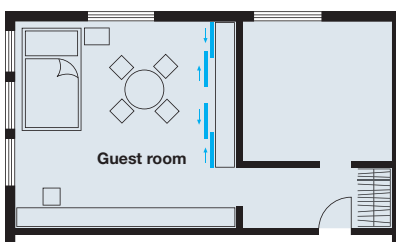

Lounge and living room divider

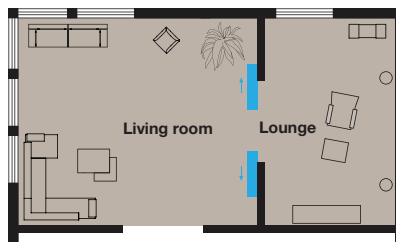

Office solutions for recesses archives

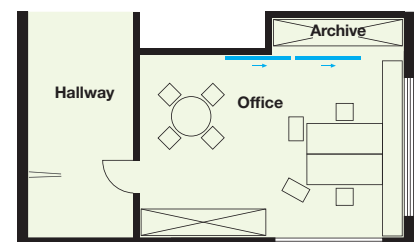

Kitchen and Dining

The candlelight for your silver wedding anniversary, the Sunday family brunch or just pasta with friends - the kitchen, the dining area and good living simply belong together, Silent Aluflex 80 provides the flexible connection between dining room and kitchen.



Version:

- H 2500 mm x W 3000 mm
- Ceiling/floor installation
- 4 door leaves
- Frame colour: Dark Bronze
- Double running and guide track
- Glue fixed running track
- Door Stop
- Brush seal
- Soft closing mechanism

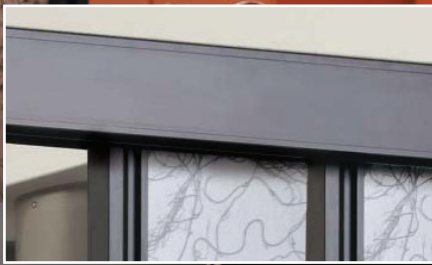

The double guide track allows the door to be installed beneath the existing soffit.

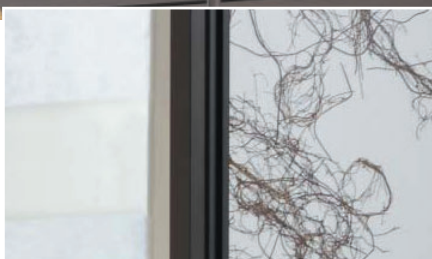

Dark bronze frame colour and the Sonoma panel blend ideally into the room.

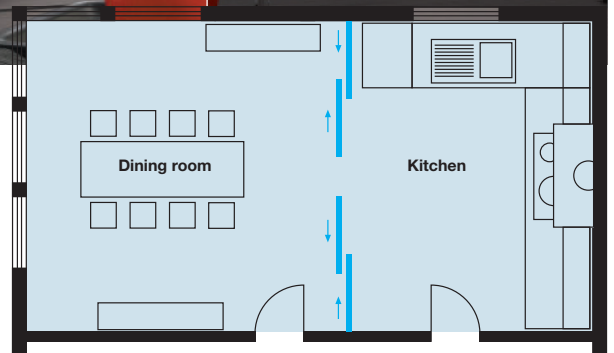

Be it the best Italian oil, mum's home-made marmalade or simply a bag of flour, you really can keep an eye on everything in this individually designed pantry, and put the contents out of sight when you silently close the sliding door behind you.

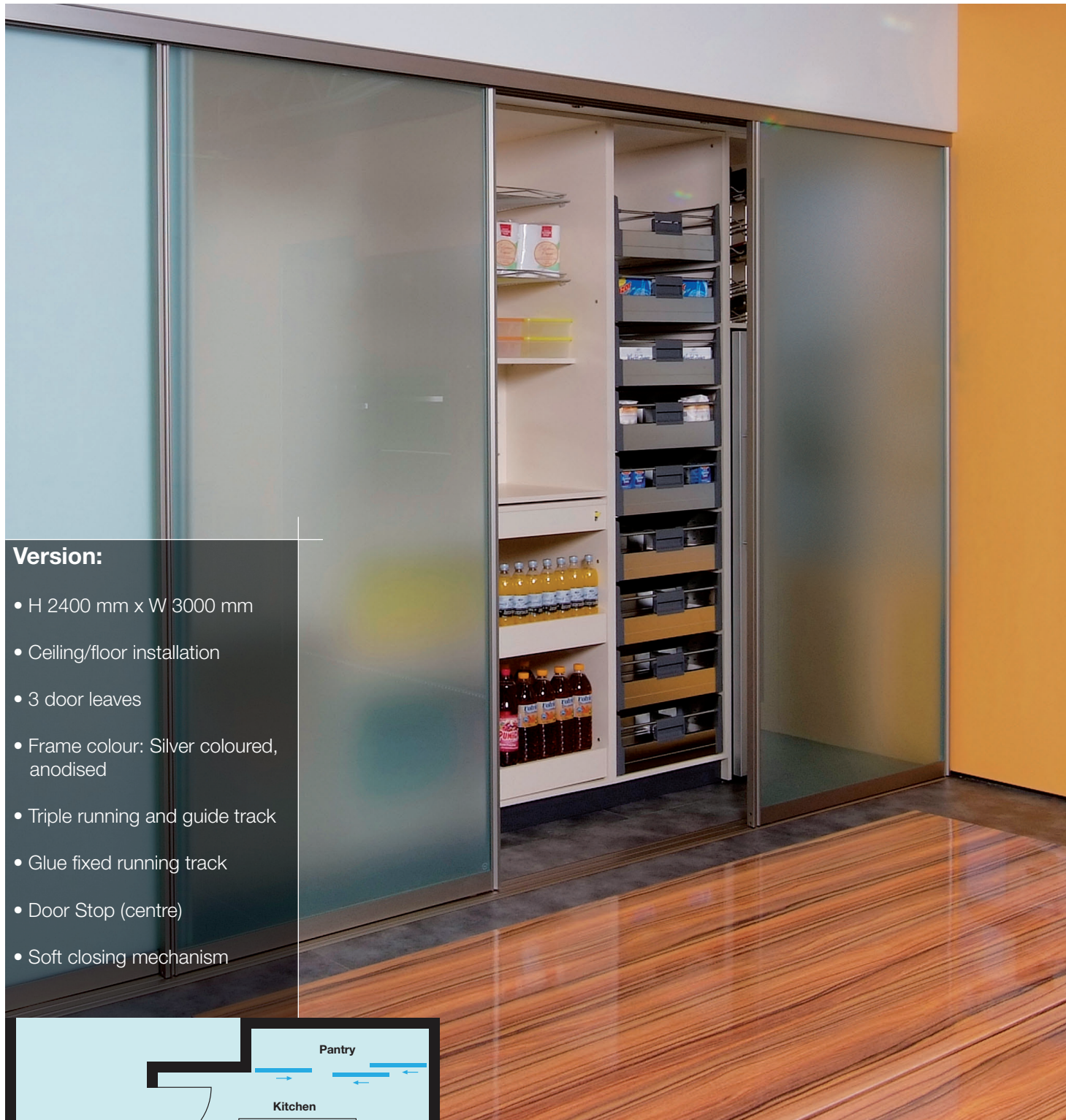

Version:

- H 2400 mm x W 3000 mm
- Ceiling/floor installation
- 3 door leaves
- Frame colour: Silver coloured, anodised
- Triple running and guide track
- Glue fixed running track
- Door Stop (centre)
- Soft closing mechanism

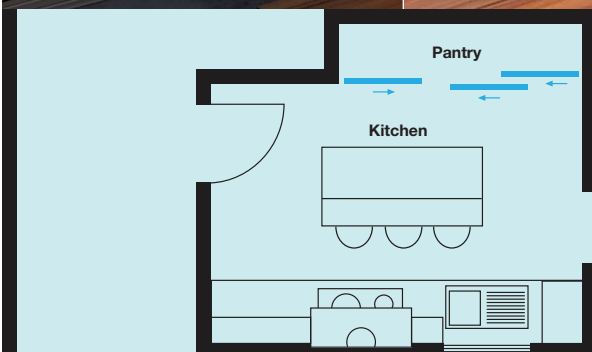

Bathroom

Sliding doors are easier to open and close than hinged doors. An everyday luxury for everyone, and a necessity for people with restricted mobility.



Version:

- H 2000 mm x W 1000 mm
- Wall mounting
- 1 door leaf
- Frame colour: Silver coloured, anodised
- Single running and guide track
- Recess mounted running track
- Soft closing mechanism

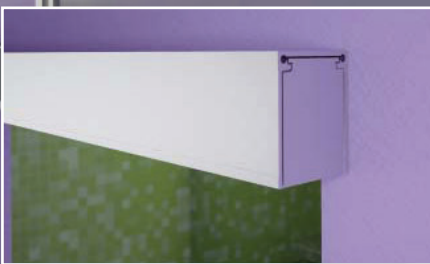

Cover caps: Ideal for finishing off the guide track.



Recessed running track: Consistently barrier free.

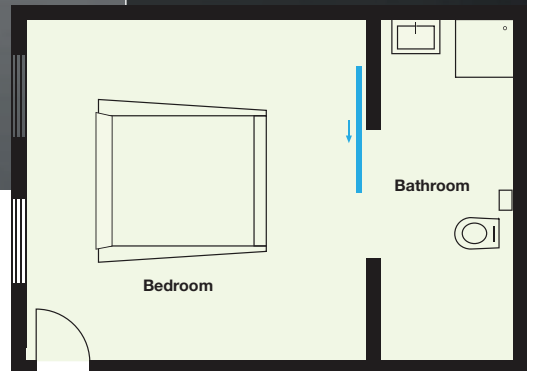

Create an aesthetically ambient wellness area, allow the bedroom & bathroom to combine or separate by simply opening or closing sliding doors.



Version:

- H 2400 mm x W 2200 mm
- Wall mounting
- 2 door leaves
- Frame colour: Silver coloured, anodised
- Glue fixed running track
- 2 bar profiles per door leaf
- Soft closing mechanism

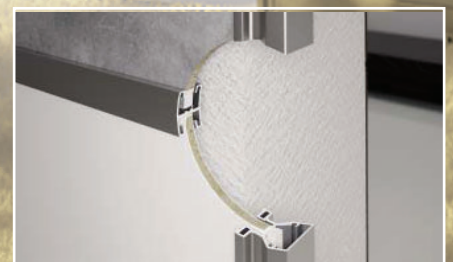
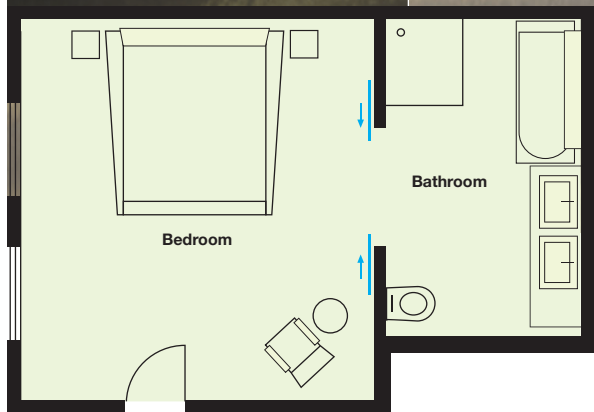

Subdividing bar profiles makes several panels in one door leaf possible.



Extremely quiet runners provide additional comfort.

Wardrobe

If you have a walk-in wardrobe, you can experience the enjoyment of choosing and trying on clothes in the convenience of your own change room.



Version:

- H 2400 mm x W 4000 mm
- Ceiling/floor installation
- 4 door leaves
- Frame colour: Silver coloured, anodised
- Double running and guide track
- Glue fixed running track
- Brush seal
- Soft closing mechanism



The guide tracks can be used for all situations.

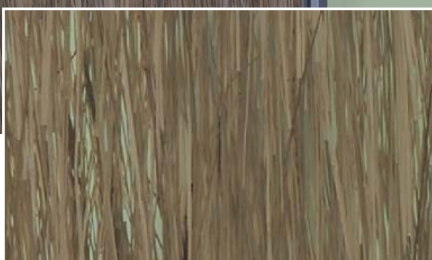

These panels with bear grass combine privacy with aesthetic.

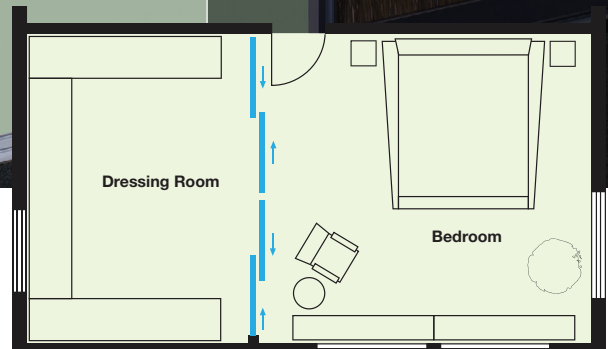

Wardrobe sliding doors open up new perspectives for all people who appreciate order and organisation just as much as their clothes and shoes. Combine with wardrobe systems for a complete wardrobe storage solution.

Version:

- H 2000 mm x W 2800 mm
- Wall mounting
- 4 door leaves
- Frame colour: Silver coloured, anodised
- Double running and guide track
- Running track recess mounted in the floor
- Brush seal
- Soft closing mechanism
- 2 bar profiles per door leaf

Bar profiles connect the different panels.

The transition from transparent to coloured material provides a varied aesthetic.

Living Rooms

A mobile shelf allows you to transform your private library into a room partition. Silent Aluflex 80 allows individual tastes to be displayed in an unusual and stylish manner.



Version:

- H 2500 mm x W 3000 mm
- Ceiling/floor installation
- 2 door leaves
- Frame colour: Silver coloured, anodised
- Single running and guide track
- Glued fixed running track
- Soft closing mechanism

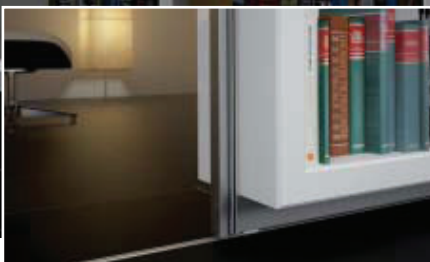

Light weight panels make a great sliding shelf.

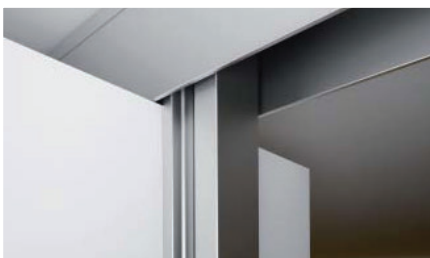

The top edge of the shelf integrates into the guide track.

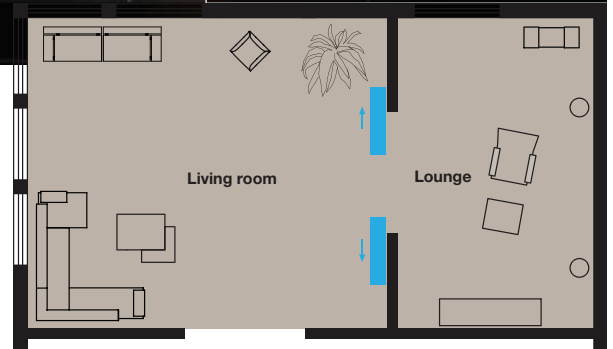

Grant yourself the luxury of designing an individual living space. Elegant sliding solutions allow you to conveniently transform your living and dining rooms into spacious room for family celebrations, or create a cosy corner in a single movement.

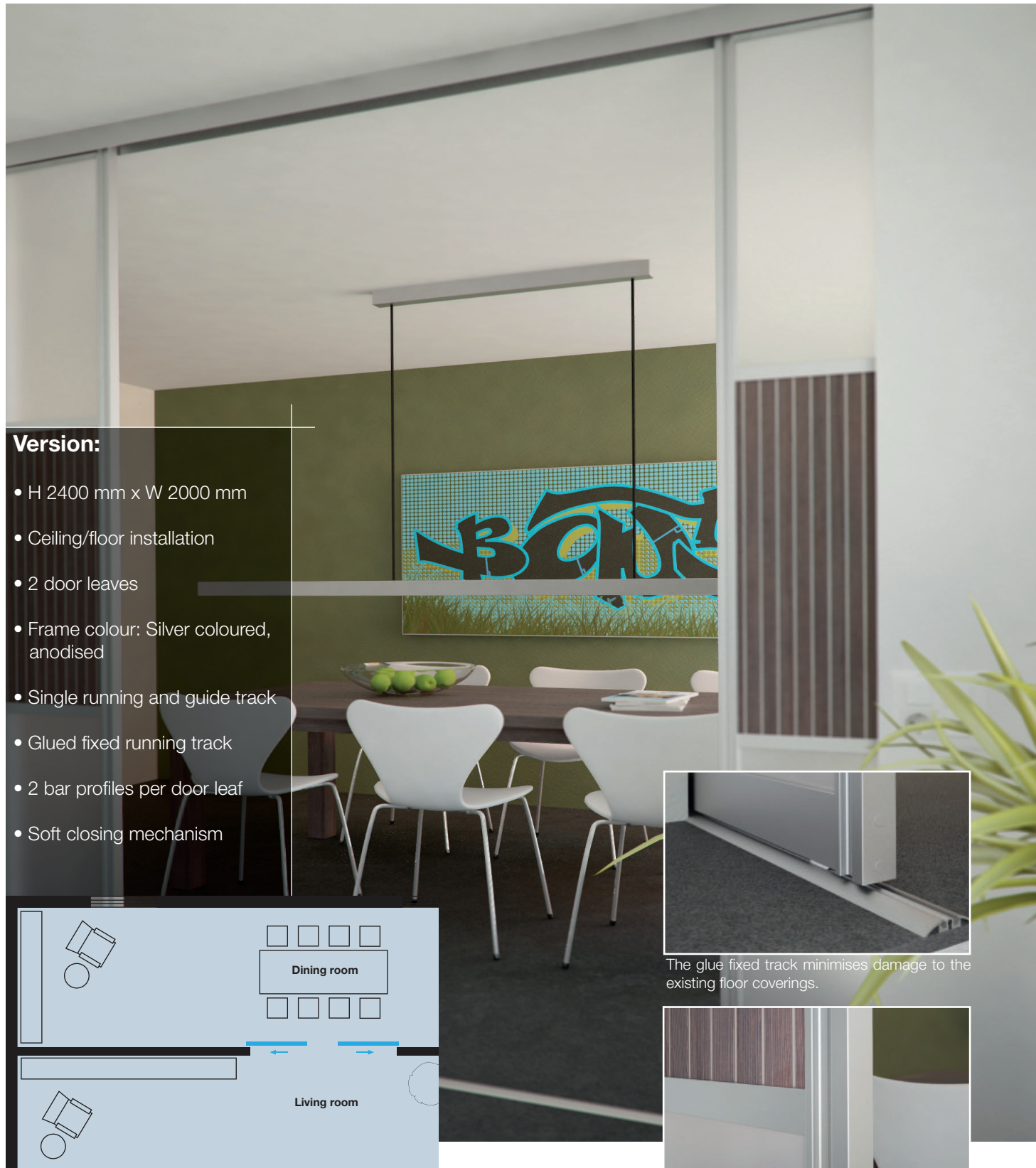

Version:

- H 2400 mm x W 2000 mm
- Ceiling/floor installation
- 2 door leaves
- Frame colour: Silver coloured, anodised
- Single running and guide track
- Glued fixed running track
- 2 bar profiles per door leaf
- Soft closing mechanism

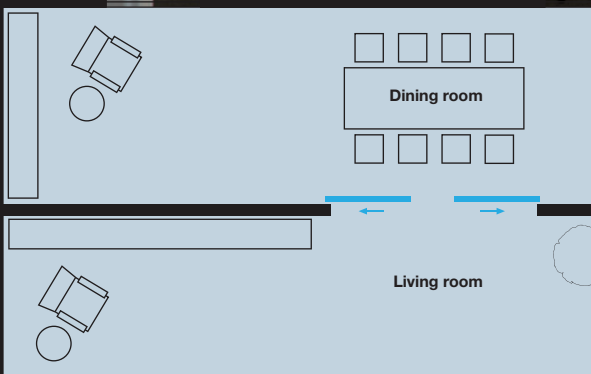

The glue fixed track minimises damage to the existing floor coverings.

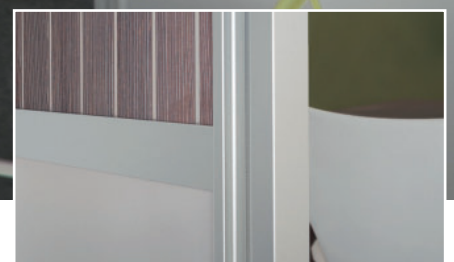

Completely customise your door panels. Shown here is acrylic with veneer attached to both sides, with stripes cut into it.

Offices

Unusual layouts often hide unused recesses and corners. A Silent Aluflex 80 sliding solution turns them into an archive, for example, in no time at all. Suitable for doctor's surgeries, lawyer's offices, executive offices and more.

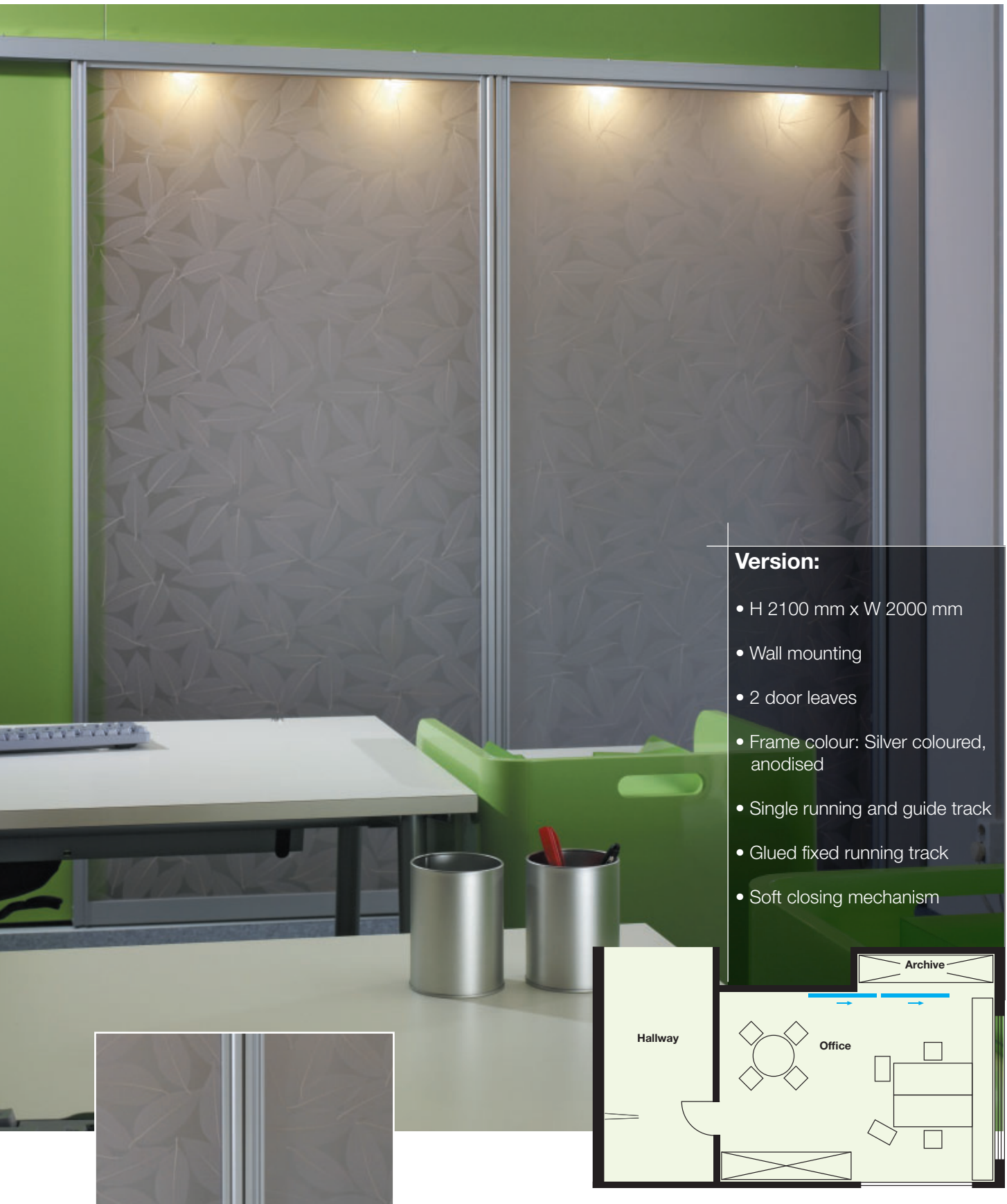

Version:

- H 2100 mm x W 2000 mm
- Wall mounting
- 2 door leaves
- Frame colour: Silver coloured, anodised
- Single running and guide track
- Glued fixed running track
- Soft closing mechanism



The colour-coordinated panel highlights the office design.

Modern working environments require new office design solutions to allow for developing shared ideas, discussing and enjoying success. Sliding doors provide the spatial flexibility that is needed to work together or on your own.



Version:

- H 2400 mm x W 2000 mm
- Ceiling/floor installation
- 2 door leaves
- Frame colour: Silver coloured, anodised
- Single running and guide track
- Glue fixed running track
- 2 bar profiles per door leaf
- Soft closing mechanism

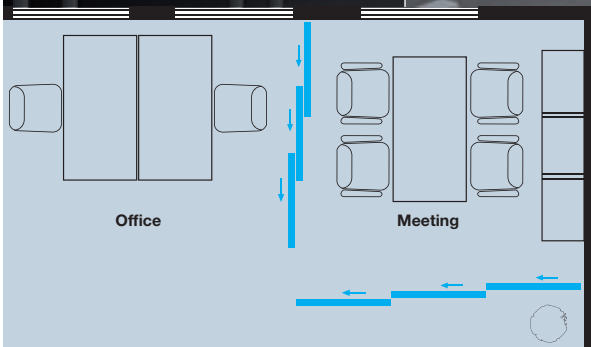

Triple running and guide track for space-saving solutions.



Brush seals on the side profiles provide protection from dust.

Insert Materials

Glass



Clear



Frosted



Mirror

Frosted Perspex™



Charcoal Dusk



Glacier Green



Chocolate



Crystal Clear

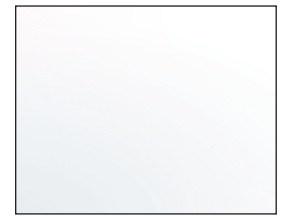

Polar White



Chilli Red



Arctic Blue

Pearlescent Perspex™

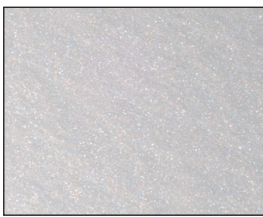

Pearl



Platinum

Please note: Colours are only a representation of the actual finish, variations may occur in the printing process.

*Acrylic, Acrylic / Natural Materials



Lucido



Frosted White

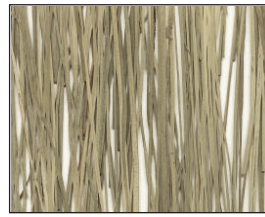

Bear Grass



Fossil Leaf



Climb



Sonoma



Ting Ting



Veneer panel

True Reflections - Acrylic Foil

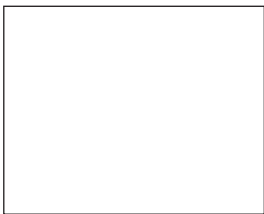

Snow



Steel



Gunn



Tusk

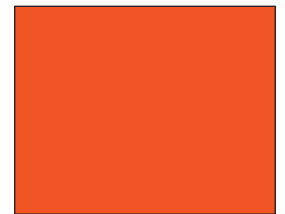

Tangerine



Scarlet

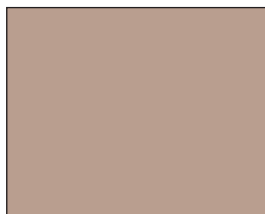

Nutmeg



Olive



Cabernet

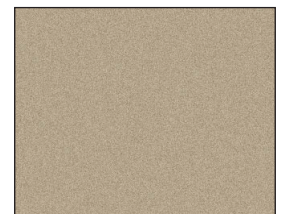

Verve



Black

*Special order. Please enquire for delivery time.

Please note: Colours are only a representation of the actual finish, variations may occur in the printing process.

Sliding door configuration and finish combination examples



Single panel (with Acrylic Climb finish)



Two panels (with Acrylic Lucido finish)



Three panels (with Acrylic Bear Grass and Frosted White)

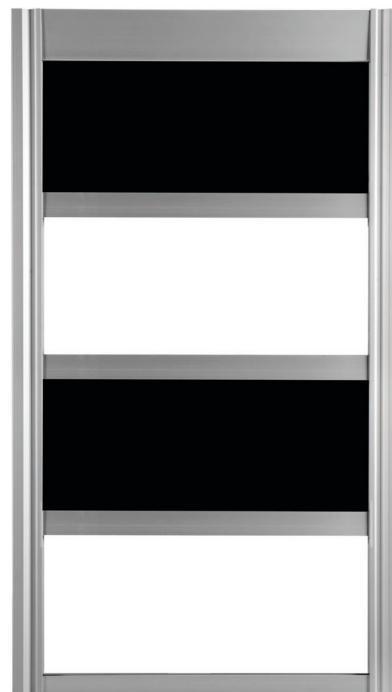

Four panels (with Acrylic True Reflections Snow and Black)

Please note: Colours are only a representation of the actual finish, variations may occur in the printing process.

Mounting of Aluminium Frame Sliding Glass Doors

With surface mounted running rails

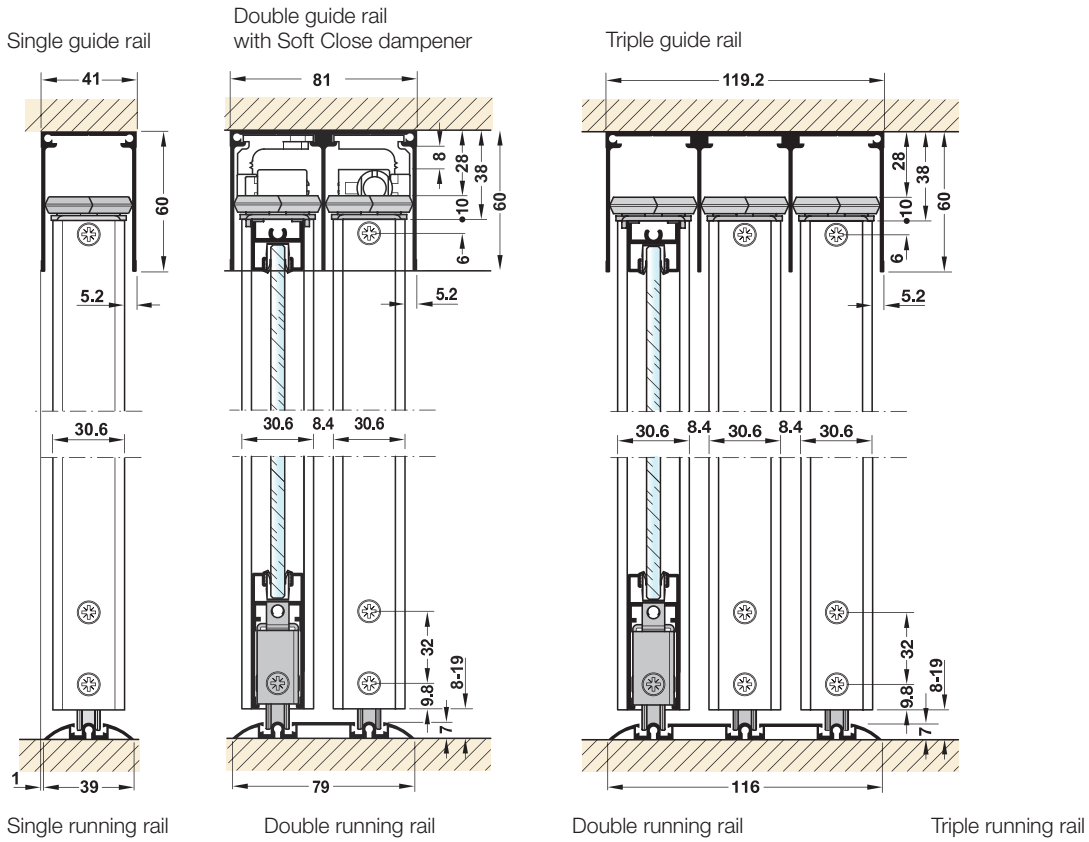

With recess mounted running rails

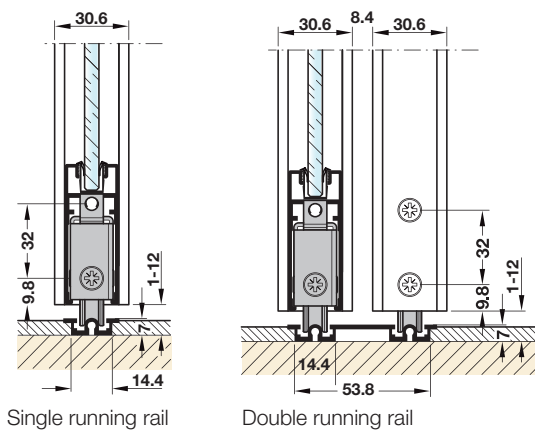

Door insert - timber, acrylic, mirror or glass

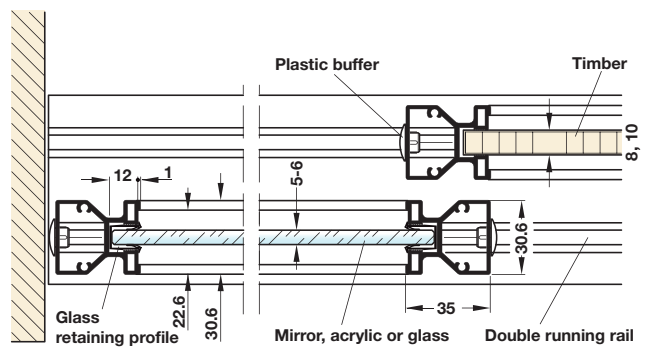

Features & Benefits

The convenience that you deserve

Unique living and operating convenience using well-engineered hardware; Large sliding doors are particularly impressive because of their maximum running safety and gentle, reliable closing over the course of many years.

Tips for easy planning

1. Measure the dimensions:

- Measure internal height and width of the entire wall opening.
- Calculate number of door leaves: Widths of 500 - 1500 mm.

2. Define special features:

- Should the top track be recessed in the ceiling or in the front of the wall?
- Should the bottom track be recess mounted in the floor covering or glued to the floor?

3. Select panels and profile finish for the doors:

- Transparent material for additional light.
- Or decorated panels for more privacy.
- Or a mixture of materials with separating bar profiles.
- With silver colour or stainless steel look profiles.

4. Choose door design:

- Use adhesive decorative bar profiles when designing large doors.
- Separating bar profiles in the frame profile allow several decorative panels to be mixed effectively.
- Dividing up the door area with bar profiles increases the amount of design freedom.

The advantages

1. The bottom rollers with their soft plastic covering are impressive because of their gentle, quiet running action, even with heavy door leaves weighing up to 80 kg.
2. The spring mounted running gears make doors easy to unhook and hang, and keep installation costs down.
3. The stable lateral frame profile can hold panel materials made from glass, acrylic, laminate and wood.
4. The Häfele SoftClosing system for automatic, gentle door closing protects hands from being trapped.

Important Information

- Maximum system height: 2500 mm.
- Maximum system width: No restriction, depends on number of leaves.
- Door leaf width: 500 to 1500 mm.
- Door leaf weight, including panels: max. 80 kg.
- Panel thickness: 5 mm - 6 mm, 8 mm and 10 mm.

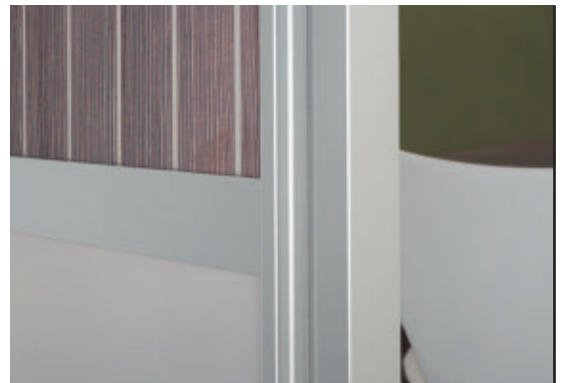

Profiles in silver colour



Profiles in stainless steel colour



Profiles in dark bronze colour*

*Special order. Please enquire for delivery time.



ALUSION Door Program

Häfele's ALUSION Door Program provides innovative solutions for a variety of applications in kitchens and furniture. All of the Aluminium doors are made to your exact measurements from one of 5 profiles and a choice of toughened and mirrored glass, frosted and pearlescent Perspex™ or True Reflections.

The Aluminium Frame Doors are available fully assembled or as a kit set, cut to size and ready for assembly.

Now available Online, www.hafele.com.au/alusion
Follow the simple step by step process online to create your individual doors, exact to your specifications.

For more information or to request a brochure contact your nearest Häfele office or visit us at www.hafele.com.au/alusion

HÄFELE
FINDING BETTER WAYS

Aluminium Frame Doors



ALUSION Door Program
September 2008

HÄFELE AUSTRALIA PTY. LTD.
STATE OFFICES

Victoria - Head Office -

8 Monterey Road, (P.O. Box 1066)
Dandenong VIC 3175
Telephone: (03) 9212 2000
Fax: (03) 9212 2001
E-mail: info@hafele.com.au

New South Wales

10 Forsyth Close,
Wetherill Park NSW 2164
Telephone: (02) 8788 2200
Fax: (02) 8788 2201
E-mail: nsw@hafele.com.au

Australian Capital Territory

1/88 Newcastle Street,
Fyshwick ACT 2609
Telephone: (02) 6202 2800
Fax: (02) 6228 1418
E-mail: act@hafele.com.au

South Australia

21 Chesser Street,
Adelaide SA 5000
Telephone: (08) 8232 9933
Fax: (08) 8232 9977
E-mail: sa@hafele.com.au

Tasmania

262 York Street,
Launceston TAS 7250
Telephone: (03) 6331 7106
Fax: (03) 6334 6414
E-mail: tas@hafele.com.au

Melbourne Design Centre

Lvl 1, 75-77 Flinders Lane,
Melbourne VIC 3000
Telephone: (03) 9212 2000
Fax: (03) 9652 3701
E-mail: info@hafele.com.au

Sydney Design Centre

115 Flinders Street,
Surry Hills NSW 2010
Telephone: (02) 8788 2200
Fax: (02) 8302 2101
E-mail: nsw@hafele.com.au

Queensland

12 Selhurst Street,
Coopers Plains QLD 4108
Telephone: (07) 3344 1533
Fax: (07) 3344 1770
E-mail: qld@hafele.com.au

Western Australia/N.T

29-33 Juna Drive,
Malaga WA 6090
Telephone: (08) 9249 3833
Fax: (08) 9249 3328
E-mail: wa@hafele.com.au

Hobart Design Centre

309 Liverpool Street,
Hobart TAS 7000
Telephone: (03) 6331 7106
Fax: (03) 6334 6414
E-mail: tas@hafele.com.au

Newcastle Design Centre

Unit 1, 47 Bolton Street,
Newcastle NSW 2300
Telephone: (02) 8788 2200
Fax: (02) 4921 0901
E-mail: nsw@hafele.com.au

Brisbane Design Centre

1 Breakfast Creek Road,
Newstead QLD 4006
Telephone: (07) 3344 1533
Fax: (07) 3253 3701
E-mail: qld@hafele.com.au

Perth Design Centre

Ground Floor, 105 St Georges Ter.
Perth WA 6000
Telephone: (08) 9249 3833
Fax: (08) 9249 3328
E-mail: wa@hafele.com.au

For all customers in country regions
call 1300 659 728

Opening Mid 2009

HÄFELE NEW ZEALAND LTD.
OFFICES & DESIGN CENTRES

Eastern Design Centre

16 Accent Drive,
East Tamaki, Auckland
Telephone: (09) 274 2040
Fax: (09) 274 2041
E-mail: info@hafele.co.nz

Wellington Design Centre

The Wool Store, Level 1
262 Thorndon Quay, Wellington
Telephone: (04) 472 0294
Fax: (04) 472 0295
E-mail: wellington@hafele.co.nz

Christchurch Design Centre

5 Wigram Close
Sockburn, Christchurch
Telephone: (03) 343 8200
Fax: (03) 343 8201
E-mail: christchurch@hafele.co.nz

Auckland Design Centre

20 Beaumont Street
St. Mary's Bay, Auckland
Telephone: (09) 274 2530
Fax: (09) 274 2531
E-mail: architectural@hafele.co.nz

Freephone 0800 4 HAFELE

HÄFELE

www.hafele.com

This catalogue is for the use of the recipient only. It remains in all respects the property of Häfele. Reproduction of this brochure in whole or in part, or the reproduction of the illustrations as well as the copying of the layout, is strictly prohibited. All measurements given in this publication are not binding. Rights for design improvements reserved. No responsibility for typographical or other errors occurring in the catalogue production. All deliveries made corresponding to Häfele sales conditions. Häfele reserves the right to adjust prices as may be deemed necessary.

2009. Copyright by Häfele. All rights reserved. Printed in Australia.

732.SI.CAT