

TESROL DOORS



www.tesroldoors.com.au



COME CLOSER TO PERFECTION

Custom Made Products

At Tesrol, it's not just about the doors. It's about style, innovation, service, product knowledge and experience in helping you create your dream home.

The Tesrol® brand was established in 1980 by the Fernandez family. Since that time we have set the industry Benchmark in Quality, Innovation and Service. Today Tesrol is a dynamic and highly driven organisation focussed on providing Premium Quality Products for your dream project. One of Tesrol's strengths is our ability to create the largest range of matching accessories available in Australia. Our dedicated design team is constantly developing new and exciting products to meet customer demands. Tesrol can also custom design items to suit your individual needs if required.

VACUUM FORMED

Tesrol has engineered the process of bonding quality PVC foil to a moisture resistant MDF substrate. We constantly monitor this process with the latest advances in technology and quality materials which make this product range even more durable. The end result is a sealed door with a seamless look and superior quality.

Finishes available are the latest European and Local trends selected by top designers resulting in over 60 colour finishes in texture, matt, wood effect and high gloss, making vacuum formed the number one choice. [Vacuum Formed products are covered by a 7 year limited guarantee on manufacturing and material faults.](#)

POLYURETHANE - Painted

Polyurethane (Two Pack) is manufactured by spraying a number of coats of High Grade paint onto a highly moisture resistant MDF substrate. Tesrol will supply all popular brand colours by name, offering you a virtually unlimited choice of colour.

Finishes available: Texture, Satin or High Gloss in solid colours only.

HAND - Painted

Tesrol can supply all products shown in this brochure routed ready for your Cabinet-maker or Painter to complete. This added freedom will allow you to achieve individual themes such as French Provincial or Milk Wash Finish.

TIMBER VENEER

Timber veneer offers the warmth and individualism of Solid Timber with the clean lines of a Modern or Contemporary Style Design.

SOLID TIMBER

Solid Timber doors are a timeless classic. Manufactured by traditional methods using state of the art technology, each door is individually assembled with its own unique grain features. Many Australian and imported species are available together with an extensive range of door styles and accessories.

ALUMINIUM FRAMED DOORS - Page 25

These exciting new aluminium framed doors complement our comprehensive range of Vacuum Formed, Routed, Painted and Timber cabinet doors and gives our customers a one-stop-shop for all their cabinet door requirements. This superior product range is aimed squarely at the discerning buyer and provides a modern and elegant addition to any home.

[Aluminium Framed door products are covered by a 10 year limited guarantee on manufacturing and material faults.](#)

DOOR DESIGNS

SOFTLINE

PAGES 4 & 5



Sleek and Stylish, Plain Face Designs with edge detail only. These edge details may be used throughout the entire Tesrol range.

TRADITIONAL

PAGES 6 & 7



Simple and Uncomplicated Face Routed Designs including edge detail.

ELEGANCE

PAGES 8 & 9



Sophisticated Designs featuring Distinctive Square Internal Corners.

COUNTRY

PAGES 10 & 11



Warm and welcoming designs featuring a recessed centre panel with or without 'V' Groove.

HERITAGE

PAGES 12 & 13



An ornate range of complex routed designs featuring raised and recessed patterns.

NEW AGE

PAGE 14



Daring and different, these designs feature a distinctive curved face.

POLYURETHANE COLOURS

PAGE 15



Our paint range is only limited by your imagination. Finish in Texture, Satin and High Gloss.

TIMBER & VENEER

PAGES 16 & 17



SOLID TIMBER

Select from our range of 12 local and imported timber species.



TIMBER VENEER

Manufactured from high quality moisture resistant MDF with real timber veneered to both sides finished with a timber edge.

ACCESSORIES



Drawer Fronts
PAGE 18



Wine Racks
PAGE 21



Bar Panels
PAGE 18



Recess Rail for Shadow Line
PAGE 21

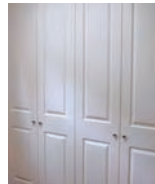

Pantry & Wardrobe Doors
PAGE 18



Canopy Rangehoods
PAGE 21



Glass & Glazing
PAGE 19



Decorative Columns & Blocks
PAGE 22



Open Shelves
PAGE 19



Fretwork
PAGE 22



Roller Shutters
PAGE 19



Skirting
PAGE 22



Capping / Cornice Mould
PAGE 20



Corbels
PAGE 23

OTHER IDEAS

PAGES 24 & 25

VACUUM FORMED COLOURS & FINISHES

PAGES 26 & 27

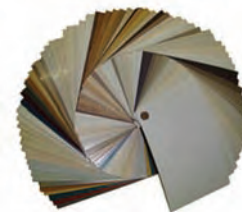

Core colours and finishes available for vacuum formed doors.

Colours and finishes are consistently being updated so please check website or enquire if colour is not shown.

CARE & MAINTENANCE

PAGE 22

Caring for your product and some guidance to correct installation and cleaning methods will give you many years of trouble free use.

SOFTLINE 100 SERIES Plain Face Doors with Edge Details



• Design 100 - Edge 3 • Vacuum Colour: Black Tulip Texture Combined with Light Beige Ren



• Design 100 - Edge 16 • Vacuum Colour: Gloss Bouari Gold



• Design 100 - Edge 3S • Vacuum Colour: Matt-SC Designer White Combined with Wenge



Design 100 - Edge 2



Design 100 - Edge 3



Design 100 - Edge 5



Design 100 - Edge 6



Design 100 - Edge 16



Design 100 - Edge 17

VACUUM FORMED COLOURS

TEXTURE & WOODGRAIN

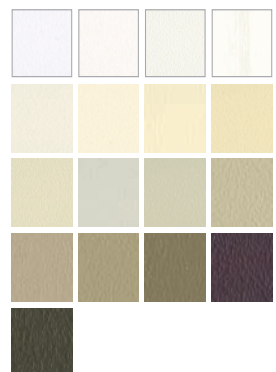

MATT & MATT SC



PRINTED



DESIGN SELECTION



Design 100 - Edge 3S



Design 100 - Edge 4



Design 100 - Edge 14



Design 100 - Edge 15



Design 100 - Edge 19

SOFTLINE Range features a Plain Face Design with edge detail only.

This Range can also be used as a guide when selecting an alternate edge detail for our other door ranges.



• Design 100 - Edge 3 • Colour: Two Tone scheme in Polyurethane



• Design 100 - Edge 3 • Vacuum Colour: Gloss Bouari Gold



• Design 100 - Edge 3S • Vacuum Colour: Gloss White Combined with Solid Timber Bench & Veneer Panels

S-COAT



GLOSS



GLOSS PREMIUM



• Larger Vacuum Formed Samples on Page 26 - 27

TRADITIONAL 200 SERIES Simple Routed Designs



• Design 201 - Edge 2 • Vacuum Colour: Gloss White



• Design 219 - Edge 16 • Vacuum Colour: Gloss Hog Bristle



Design 260 - Edge 3S



Design 219 - Edge 2



Design 219 - Edge 3



Design 219 - Edge 3S



Design 219 - Edge 4



Design 219 - Edge 5



Design 219 - Edge 14

TRADITIONAL Range features simple Face Routed Designs.

All of these designs can use Softline edge detail except for 230,232,233, 240 and 260



Design 219 - Edge 15



Design 219 - Edge 16



Design 219 - Edge 17



Design 219 - Edge 19



Design **200** - Edge **3**



Design **201** - Edge **2**



Design **216** - Edge **2**



Design **250** - Edge **3**



Design **212** - Edge **3S**



Design **223** - Edge **3**



Design **224** - Edge **3**



Design **240** - Edge **4**



Design **204** - Edge **3**



Design **205** - Edge **3**



Design **208** - Edge **3**



Design **209** - Edge **3S**



 Design **230** - Edge **3**



 Design **232** - Edge **3**



 Design **233** - Edge **3S**

 **DESIGNS 230, 232 & 233 AVAILABLE IN PAINTED ONLY**

VACUUM FORMED COLOURS

TEXTURE & WOODGRAIN

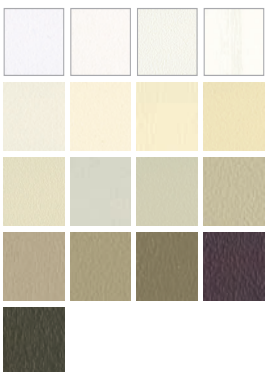

MATT & MATT SC



PRINTED

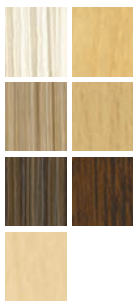

S-COAT



GLOSS



GLOSS PREMIUM



• Larger Vacuum Formed Samples on Page 26 - 27



• Design 438 - Edge 2 • Vacuum Colour: New Antique White Ren



• Design 400 - Edge 17 • Vacuum Colour: Matt-SC Classic White



• Design 412 - Edge 17 • Vacuum Colour: Matt-SC Designer White



Design **400** - Edge **2**



Design **404** - Edge **3**



Design **412** - Edge **3S**



Design **416** - Edge **3**



Design **418** - Edge **3**



Design **422** - Edge **2**



Design **426** - Edge **3**



Design **427** - Edge **2**



Design **430** - Edge **3S**



Design **434** - Edge **3**



Design **438** - Edge **3**



Design **439** - Edge **2**



Design **455** - Edge **3S**



Design **456** - Edge **3**



Design **486** - Edge **3**



Design **487** - Edge **3**

TEXTURE & WOODGRAIN



MATT & MATT SC



PRINTED



S-COAT



GLOSS

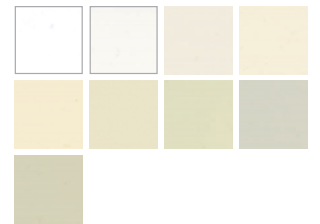

GLOSS PREMIUM



• Larger Vacuum Formed Samples on Page 26 - 27

PAINTED COLOURS - PAGE 15



COUNTRY 500 SERIES Recessed Flat Panel with or without 'V' Grooves



• Design 575 - Edge 2 • Vacuum Colour: Matt-SC New Antique White



• Design 576 - Edge 2 • Vacuum Colour: Designer White Ren

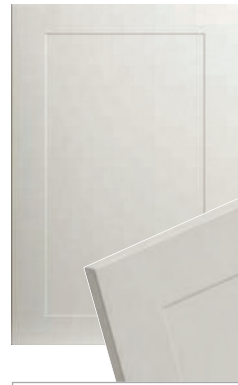

Design 502 - Edge 3S



Design 504 - Edge 3S

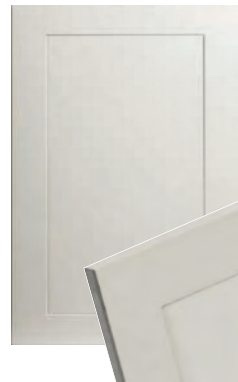

Design 520 - Edge 3



Design 560 - Edge 3S

DESIGNS 520 & 560 AVAILABLE IN PAINTED ONLY



Design 506 - Edge 3



Design 570 - Edge 3



Design 575 - Edge 2



Design 576 - Edge 2



Design 586 DVG - Edge 2

VACUUM FORMED COLOURS

TEXTURE & WOODGRAIN



MATT & MATT SC



PRINTED



S-COAT



GLOSS

GLOSS PREMIUM

GLOSS & GLOSS PREMIUM
Not available in
COUNTRY Series
Vacuum Formed Designs.

GLOSS is available in
POLYURETHANE Painted finish.

• Larger Vacuum Formed Samples on Page 26 - 27

HERITAGE 600 SERIES

An ornate range of complex routed designs.



• Design 609 - Edge 3 • Hand Painted Finish



• Design 604 - Edge 3S • Hand Painted Finish



Design 600 - Edge 2



Design 601 - Edge 2



Design 602 - Edge 3



Design 603 - Edge 3



Design 604 - Edge 2



Design 605 - Edge 2



Design 606 - Edge 3



Design 609 - Edge 3



Design 623 - Edge 3



Design 631 - Edge 3S



Design 634 - Edge 3S
Available in painted only



• Design 609 - Edge 3 • Vacuum Colour: Matt-SC Designer White

VACUUM FORMED COLOURS

TEXTURE & WOODGRAIN

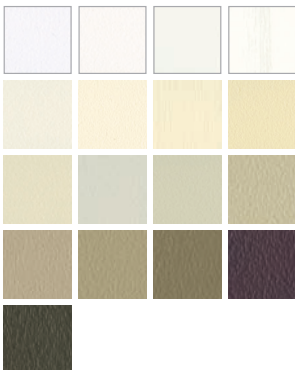

MATT SC ONLY



PRINTED



S-COAT



GLOSS

GLOSS PREMIUM

GLOSS & GLOSS PREMIUM
Not available in
HEIRTAGE Series
Vacuum Formed Designs.

GLOSS is available in
POLYURETHANE Painted finish.

• Larger Vacuum Formed Samples on Page 26 - 27

NEW AGE 700 SERIES



• Design 710 - Edge 3S • Hand Painted Finish



• Design 710 - Edge 3S • Vacuum Colour: Matt White



• Design 710 - Edge 3S • Hand Painted Finish

DESIGN SELECTION

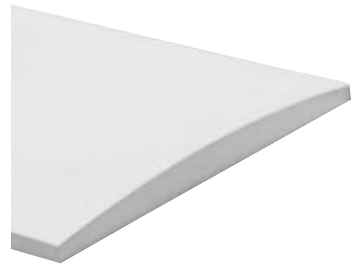

Design 710 - Edge 3S

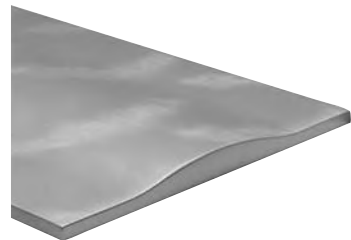

Design 720 - Edge 3S

VACUUM FORMED COLOURS

TEXTURE & WOODGRAIN

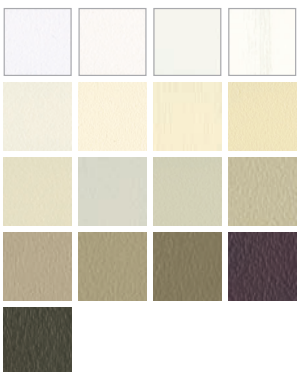

MATT SC ONLY



PRINTED



S-COAT



GLOSS

GLOSS PREMIUM

GLOSS & GLOSS PREMIUM
Not available in
NEW AGE Series
Vacuum Formed Designs.

GLOSS is available in
POLYURETHANE Painted finish.

• Larger Vacuum Formed Samples on Page 26 - 27

POLYURETHANE - PAINT

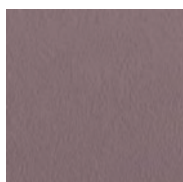

TEXTURE

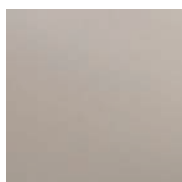

SATIN
30% Sheen

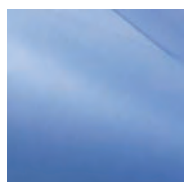

HIGH GLOSS
85-100% Gloss

Tesrol can now offer customers the flexibility of products finished in polyurethane.

This level of freedom will allow a far greater choice of both colour and design .

Tesrol will match all popular brand colours by name.

FINISHES AVAILABLE

Satin finish will be generally 30% Sheen.
Gloss finish will be 85-100% Sheen.

Please note: Tesrol cannot accept responsibility for product supplied which does not match other finishes pre-painted in the home

TIMBER VENEER

Create a Modern Warm Environment



• Design: Timber Veneer with 2mm Edge • Species: **Southern Myrtle**

SOLID TIMBER

Create a Timeless Classic



• Design: Square • Rail: Standard
• Panel: Raised Solid • Species: **Tasmanian Blackwood**



• Design: Square • Rail: Standard
• Panel: Raised Solid • Species: **Canadian Rock Maple**



Design: Square
 Rail: Standard
 Panel: Raised Solid
Southern Myrtle



Design: Arch
 Rail: Standard
 Panel: Raised Solid
Jarrah



Design: Double Arch
 Rail: Standard
 Panel: Raised Solid
Tasmanian Blackwood



Design: Square
 Rail: Standard
 Panel: 'V' Groove Solid
Canadian Rock Maple



Design: Square
 Rail: Standard
 Panel: Flat Panel Veneer
American Oak



Design: Veneer Door
 Rail: N/A
 Panel: N/A
Southern Myrtle



Design: Veneer Door
 Rail: N/A
 Panel: N/A
Tasmanian Blackwood



Design: Square
 Rail: Bevel
 Panel: Flat Panel Veneer
New Guinea Rosewood



Design: Square
 Rail: Shaker
 Panel: Flat Panel Veneer
Southern Myrtle



Design: Square
 Rail: Victorian
 Panel: Flat Panel Veneer
Tasmanian Oak

SOLID TIMBER - FRAME & PANEL OPTIONS



RAIL: STANDARD
 PANEL: RAISED SOLID OR FLAT PANEL VENEER



RAIL: SQ 0
 PANEL: FLAT PANEL VENEER



RAIL: SHAKER
 PANEL: FLAT PANEL VENEER



RAIL: BEVEL
 PANEL: FLAT PANEL VENEER



RAIL: VICTORIAN
 PANEL: FLAT PANEL VENEER

SOLID TIMBER - FRAME & VENEER SPECIES



Radiata Pine
Group: A



Tasmanian Oak
Group: B



American Oak
Group: C



Oregon
Group: C



Southern Myrtle
Group: C



New Guinea Rosewood
Group: C

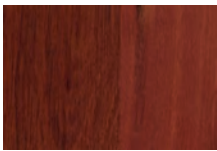

Jarrah
Group: C



European Beech
Group: D



Sapele
Group: D



Tasmanian Blackwood
Group: D



QLD Blackwood
Group: D



Canadian Rock Maple
Group: E

DRAWERS



- Timber 2 drawer set in square design and 4 Drawer set in plain design.



- Vacuum formed individually Routed Drawers.



- Vacuum formed drawer cut from a door

BAR PANELS



- Timber Bar Panels individual



- Routed bar panel hand painted

PANTRY & WARDROBE DOORS



- Timber Pantry Doors



- Vacuum formed high gloss with interlock wine rack



- Full length pantry doors and split pantry doors with decorative display

GLASS FRAMES & GLAZING BARS



- Glass Frame with clear glass.



- Glass Frame with Frosted glass.



- Glazing Bars with 6 windows and clear glass, number of windows may be altered.

OPEN SHELVES



- Angled open shelf in Timber Veneer.



- Round Open shelf unit in base unit incorporating interlock wine rack in Vacuum Formed.



- Open Shelf unit used as book shelves in entertainment unit in Vacuum Formed.

ROLLER SHUTTERS



- Roller shutter in corner above bench top.



- Roller shutter in vacuum formed with sliding shelf over benchtop for easy access to coffee making.

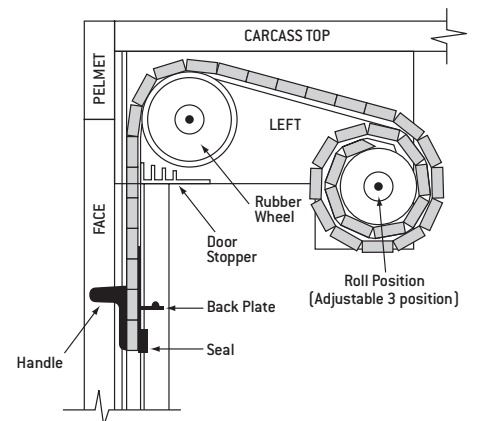

- Cross Sectional diagram of roller shutter unit.

CAPPING / CORNICE MOULD

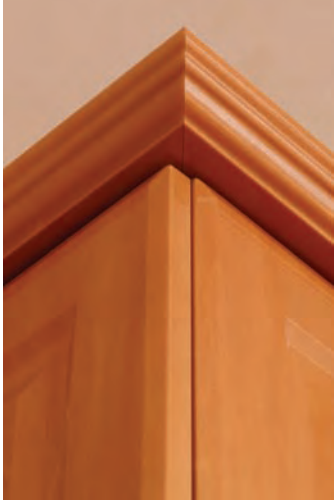

BEVEL



BULLNOSE

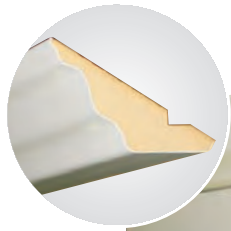

FEDERATION



SCULPTURED

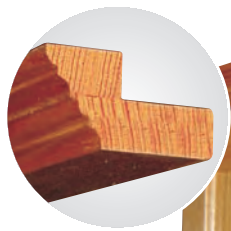

2 PIECE TIMBER



DENTAL

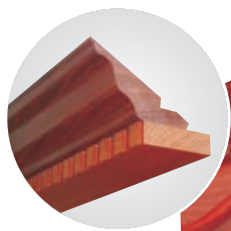

FEDERATION & DENTAL BASE



DENTAL BASE

- Dental Base can be added to enhance our Federation, Bevel, Bullnose or Sculptured Capping.

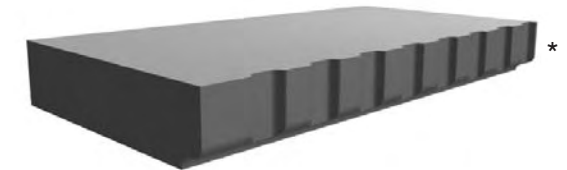

- Available in Vacuum Formed, Painted & Solid Timber.

Tesrol produces the largest range of pre-finished capping mould in Australia. Whether your project is Modern, Traditional, or Ornate there is a style designed to suit.

WINE RACKS

- WINE RACKS are available in kit form designed for your cabinetmaker to simply intergrate into your project.
- Available in various finishes.

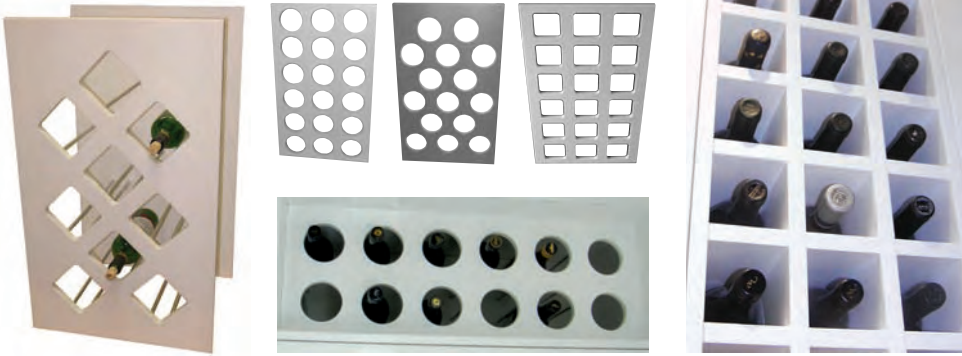

RECESS RAIL

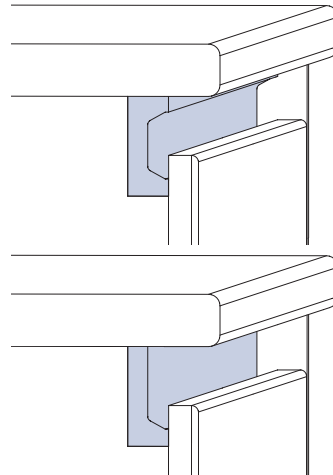

- The current Trend in kitchen design is for clean unclutered lines. To achieve this look Tesrol have developed our Recess Rail which is available in either Vacuum Formed or Painted finishes.

CANOPY RANGEHOODS



- Tesrol now produces assembled Ornate rangehood canopies, allowing your cabinetmaker to add that old world charm to your kitchen.
- Available in Raw or Painted finishes only.



DECORATIVE COLUMNS & BLOCKS



COLUMNS



- Decorative Columns and Blocks are perfect for adding old world charm to your project.
- Available in Vacuum Formed, Painted & Solid Timber.

BLOCKS

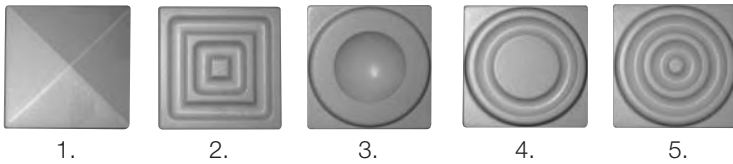

FRETWORK

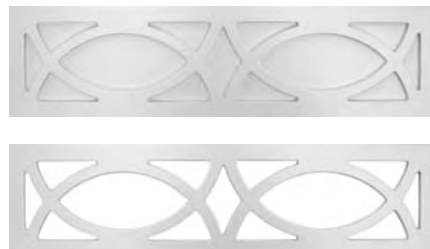

- Tesrol now manufactures custom size Fretwork.
- The Open version is available in Timber & Painted, and the closed version is also in Vacuum Formed.

SKIRTING



- Matching Skirting is an important aspect of getting you project looking perfect.
- Available in Vacuum Formed, Painted & Solid Timber.

CARE & MAINTENANCE

Caring for your Tesrol Doors

Your Tesrol Doors and Panels are easily cleaned using a solution of mild soapy water and a soft cloth.

More persistent stains may be treated with methylated spirits followed by soapy water. Never use solvent based or abrasive cleaners which could damage the surface.

Excessive heat can cause damage, so it is important to ensure the following.

- Always use your rangehood when cooking.
- Avoid having toasters, coffee machines etc. in a position where heat is constantly being subjected to the product's surface.

Heat Deflectors

Some ovens which are flush mounted are not designed to deflect heat away from Surrounding surfaces.

Important to ensure the following.

- Tesrol supply Heat deflector strips in black, white or chrome, which must be used to protect your doors and panels.
- Failure to correctly install heat deflectors may void the product warranty.

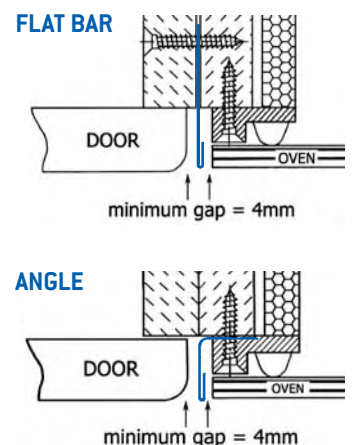

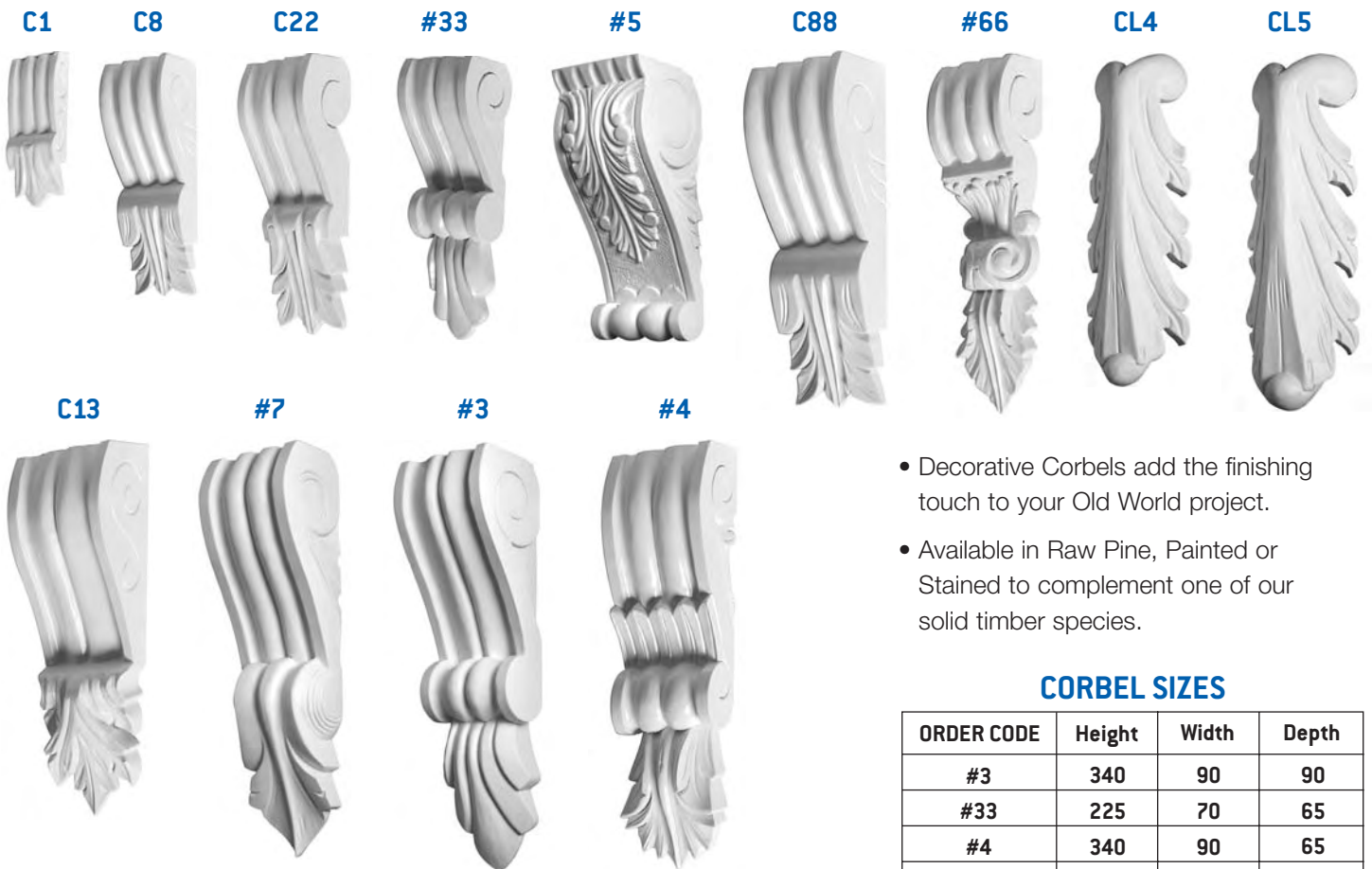

- Decorative Corbels add the finishing touch to your Old World project.
- Available in Raw Pine, Painted or Stained to complement one of our solid timber species.

CORBEL SIZES

ORDER CODE	Height	Width	Depth
#3	340	90	90
#33	225	70	65
#4	340	90	65
#5	230	90	90
#66	290	70	70
#7	335	90	90
C1	115	42	19
C13	300	90	85
C22	225	70	65
C8	195	70	65
C88	285	90	85
CL4	265	65	65
CL5	285	70	70
S1	70	70	19
T2 (X2)	115	115	19
TB2	125	90	35
TB3	145	120	35
TB4	145	120	35

- Example of Corbel #3 with top block TB3

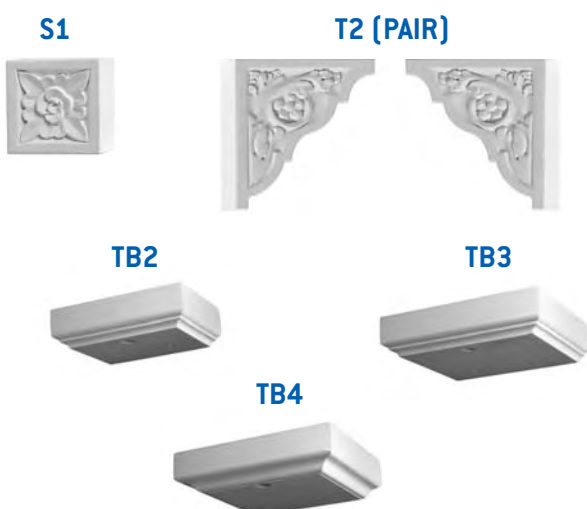

OTHER IDEAS USING TESROL PRODUCTS



HOME THEATER

Timber doors / Panels and moulding used as the main feature.



DISPLAY CUPBOARD

Combination of cupboard doors and open shelves to decorate an empty wall in a lounge / family room.



TV ENTERTAINMENT UNIT

Combination of base cabinet and wall mounted cabinet.



WARDROBE CABINET

Full length wardrobe doors.



ENTERTAINMENT UNIT

Hand painted doors used in this wall cabinet around decorated fireplace with a mini bar and wall mounted LCD TV.



WALL UNIT AROUND FIREPLACE

Fireplace incorporating ornate mouldings and painted doors, shelving and decorative products.

ALUMINIUM FRAMED DOORS



40mm Flat Profile - Milky White Glass



Our Aluminium Framed doors come in 3 distinctive styles:

FLAT

CURVED

BOX



Tesrol Aluminium Framed Doors

These exciting new aluminium framed doors compliment our comprehensive range of Vacuum Formed, Routed, Painted and Timber cabinet doors and gives our customers a one-stop-shop for all their cabinet door requirements. This superior product range is aimed squarely at the discerning buyer and provides a modern and elegant addition to any home.

There are 3 frame styles in a variety of widths and 12 glass, mirror or perspex inserts to choose from.

All our aluminium extrusions are of the highest grade and are imported from Europe. Only the highest quality fixings, hinges, runners and insert panel materials are used ensuring that your doors are right first time.

Every single door is created by highly skilled specialists who value quality above everything else. Our guarantee to you is that every possible effort has been put into ensuring that your design will be functional, practical and aesthetically pleasing.

As part of their commitment to quality we provide a 10 year assembly warranty on all of the aluminium cabinet door range.



VACUUM FORMED

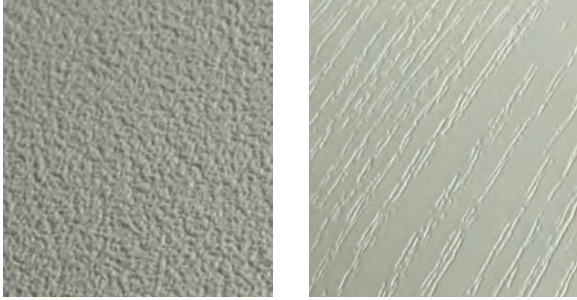

TEXTURE & WOODGRAIN



Designer White Ren



Classic White Ren



LX White Ren



White Woodgrain Satin

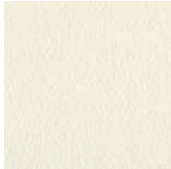

Alabaster Ren

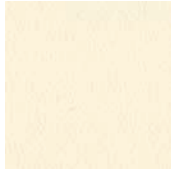

New Antique White Ren



New Antique White Woodgrain

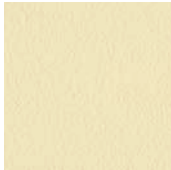

Light Beige Ren

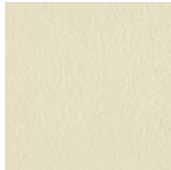

Hog Bristle Ren



Royal Oyster Ren

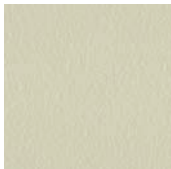

White Duck Ren



New Flannel Texture



New Oyster Texture

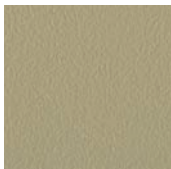

Bouari Gold Ren

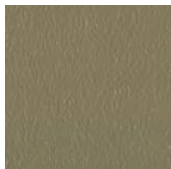

New Tobacco Texture



Black Tulip Texture

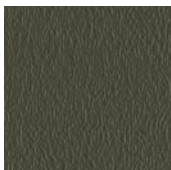

Espresso Texture



MATT-SC **NEW**



Matt-SC Designer White



Matt-SC Classic White



Matt-SC Alabaster

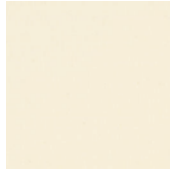

Matt-SC New Antique White



Matt-SC Hog Bristle



Matt-SC Royal Oyster



Matt-SC White Duck

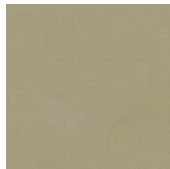

Matt-SC Bouari Gold

The new Matt-SC range has been developed to give a unique Soft Touch finish with higher durability.

This New fashion range of colours is also available in Texture and Gloss exclusively through Tesrol.



PRINTED



Creme Fino



New Fusion Maple



Chambery Fino

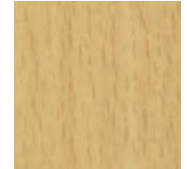

Natural Beech



Mocha Fino

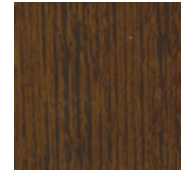

Wenge

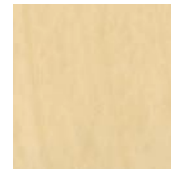

Light Birch

MATT



Matt White



Matt LX White Ren



Matt Antique White

For the latest up to date colours Please visit our



S-COAT NEW



Birch



Venetian



Marseille



Teak



Antique Oak



Walnut

S-Coat is a New highly durable finish now available in Australia, exclusively through Tesrol.



GLOSS



Gloss White



Gloss Classic White

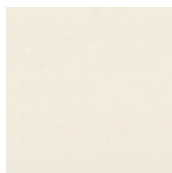

Gloss Alabaster

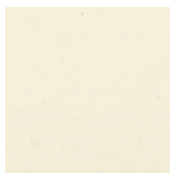

Glass New Antique White

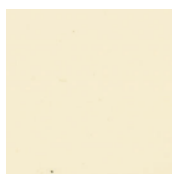

Gloss Antique White

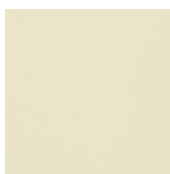

Gloss Hog Bristle



Gloss Tec White

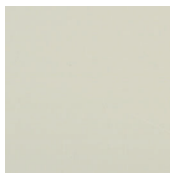

Gloss Royal Oyster



Gloss White Duck

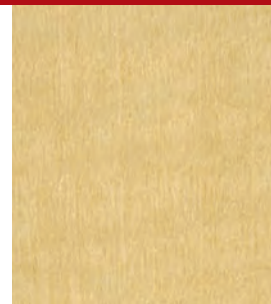

GLOSS PREMIUM

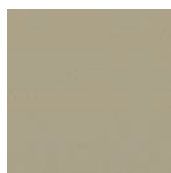

Gloss Bouari Gold



Gloss Dark Beige



Gloss Mocha



Gloss Soft Maple

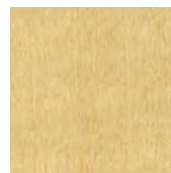

Gloss Beech

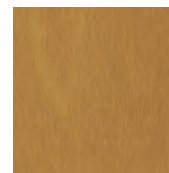

Gloss Dark Maple



Gloss Bouari Grey

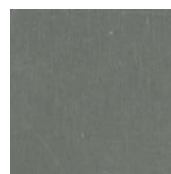

Gloss Brushed Stainless

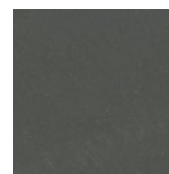

Gloss Metallic Gunmetal



Gloss Rosso

The Vacuum Formed colours displayed on these two pages are the latest in European fashion incorporated into the Tesrol Collection.

Due to limitations in the printing process, colours may vary to actual colour samples which can be requested for true colour matching.



It's not just about the doors

TESROL HEAD OFFICE

405 Victoria Street
Wetherill Park, NSW 2164 Australia
Telephone: (02) 9604 5600
Facsimile: (02) 9604 5052
Email: sales@tesroldoors.com.au
Website: www.tesroldoors.com.au

VICTORIAN BRANCH - OFFICE

Telephone: (03) 9873 5152
Facsimile: (03) 9873 5156

PROUDLY DISTRIBUTED BY:

J.S. Robinsons

158 Victoria Street North Geelong VIC 3215
Telephone: (03) 5277 0788
Facsimile: (03) 5277 9712

GLS

20-24 Harris Road Griffith NSW 2680
Telephone: (02) 6964 4888
Facsimile: (02) 6962 4822

Veneer Panels

27 Nylex Avenue Salisbury South SA 5106
Telephone: (08) 8281 3444
Facsimile: (08) 8281 3184

To see a select range of Tesrol products visit your nearest
HOME IDEAS CENTRE - Open 7 days

Victoria: 1686 Princess Hwy Oakleigh East 3166
South Australia: Cnr Anzac Hwy & South Rd Ashford 5035
Queensland: 66 Merivale St South Bank West End 4101
Tasmania: 295-315 Liverpool St Hobart 7000
262 York St Launceston 7250

www.tesroldoors.com.au